

SME:
 company representatives: _____

DESIGNERS:

Strategic PES (Product-Experience-Service) by Ricardo Mejía
 e: jrmejias@pktweb.com | b: http://dive.pktweb.com/
 // Print on A0 (841 x 1189 mm) B&W, one side, 52gsm recycled newsprint

Date: _____

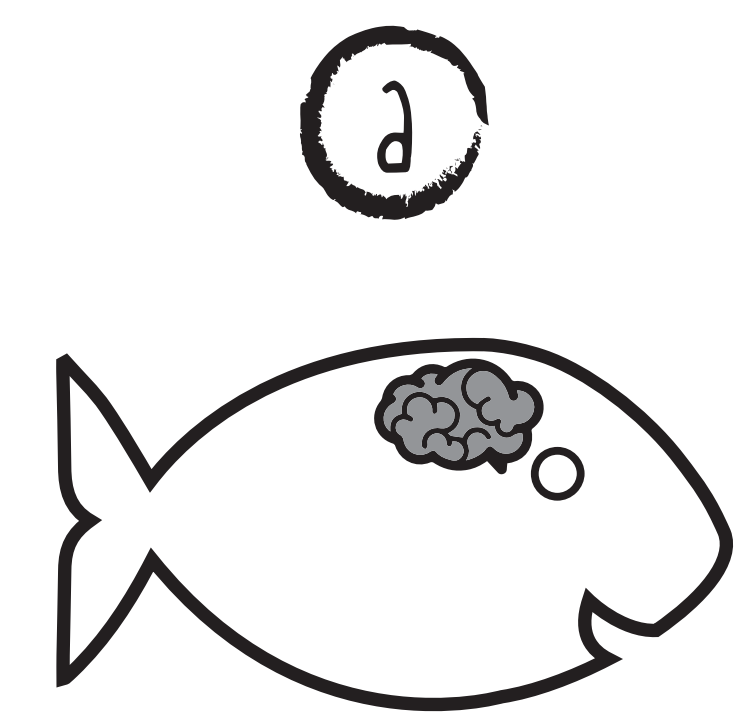

KNOW - HOW & VALUES

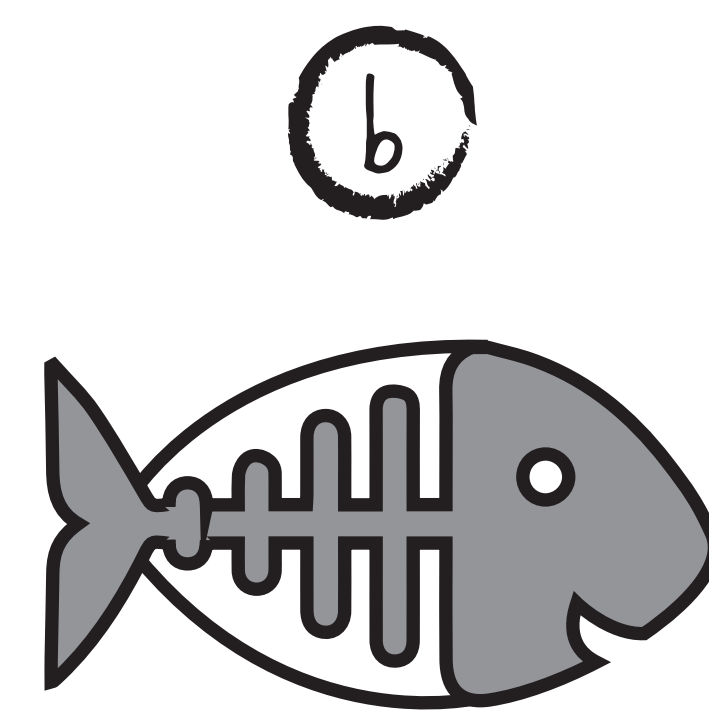

USERS

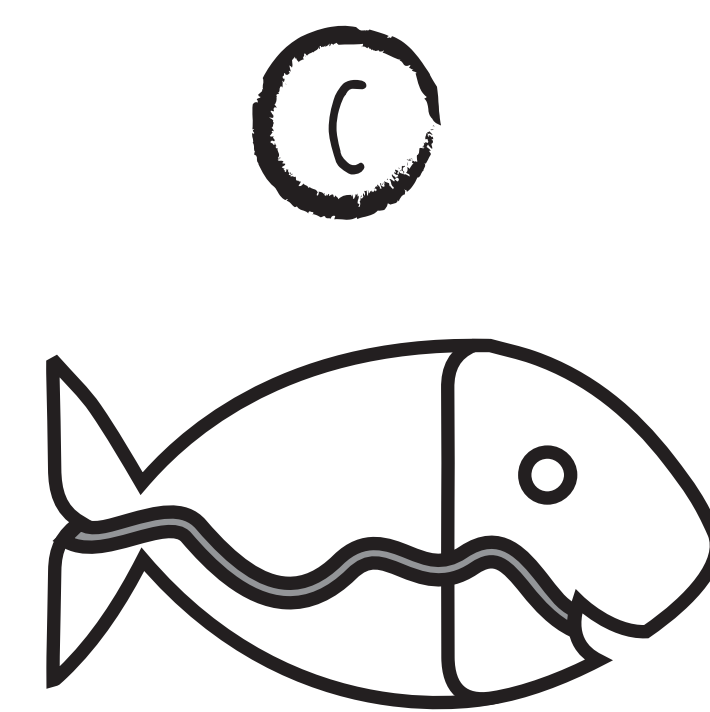

PRODUCT & SERVICES

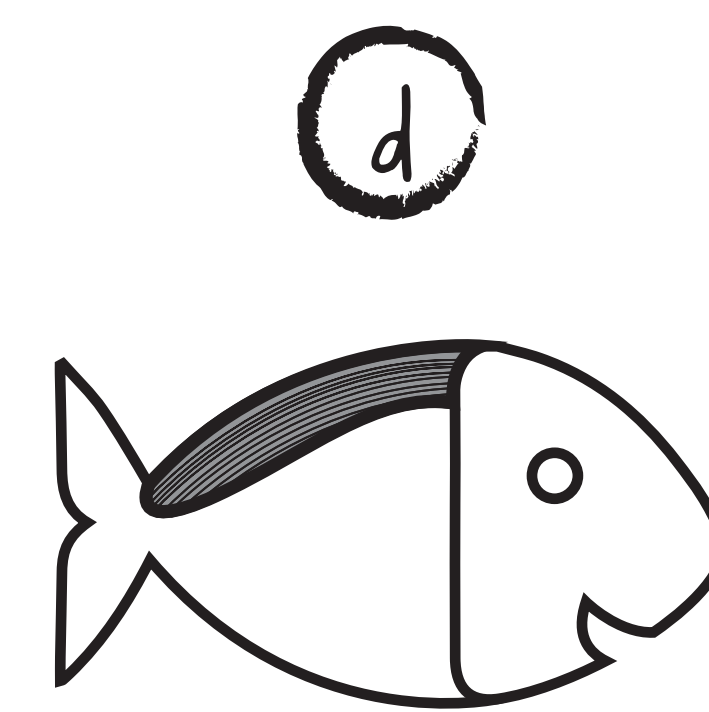

FACILITIES & STAKEHOLDERS

Domain:

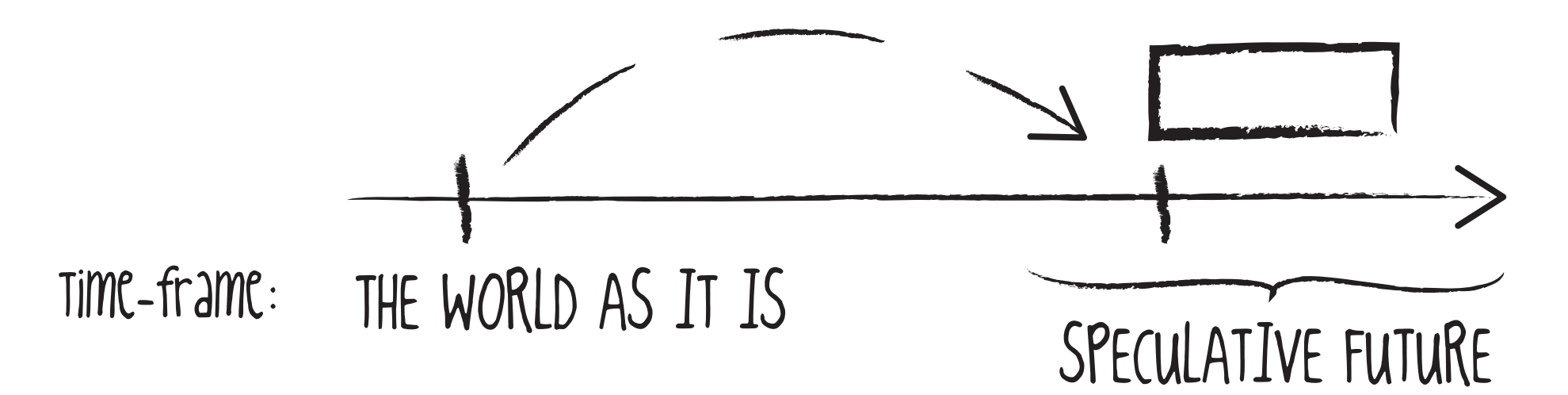

e

f

g

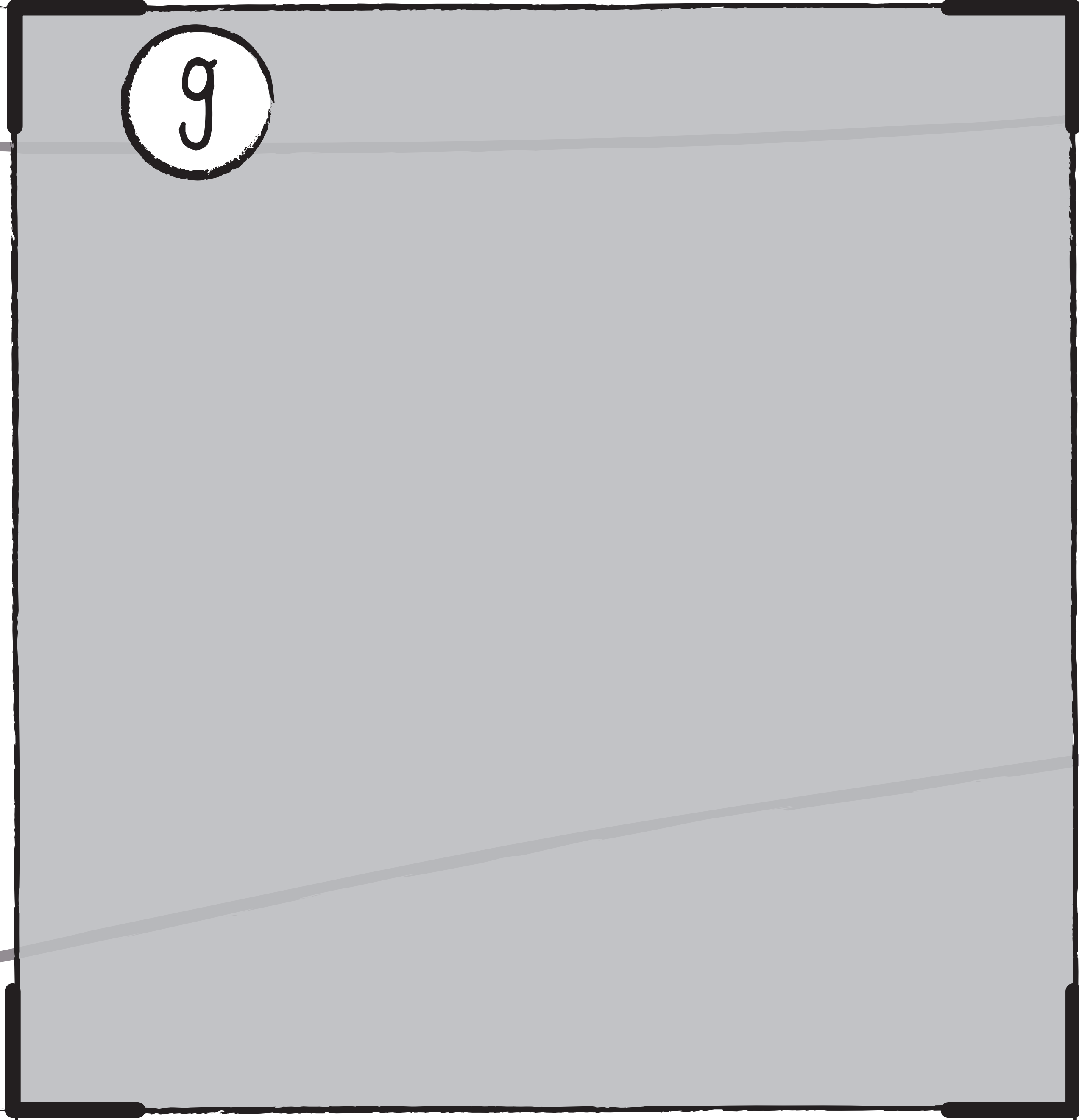

SME:
company representatives:

DESIGNERS:

Strategic PES (Product-Experience-Service) by Ricardo Mejía
e: jrmejias@pktweb.com | b: http://dive.pktweb.com/
// Print on A0 (841 x 1189 mm) B&W, one side, 52gsm recycled newsprint

Date:

Dive 0.3

e

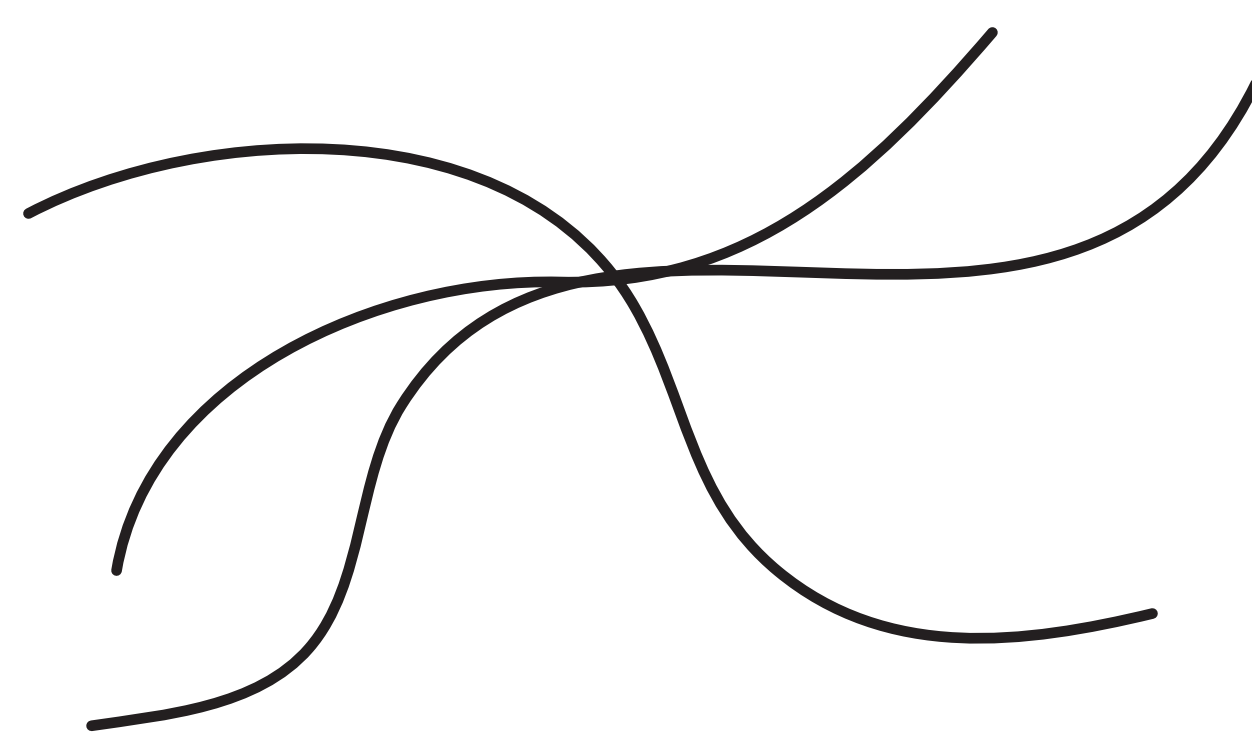

TRENDS & DEVELOPMENTS

f

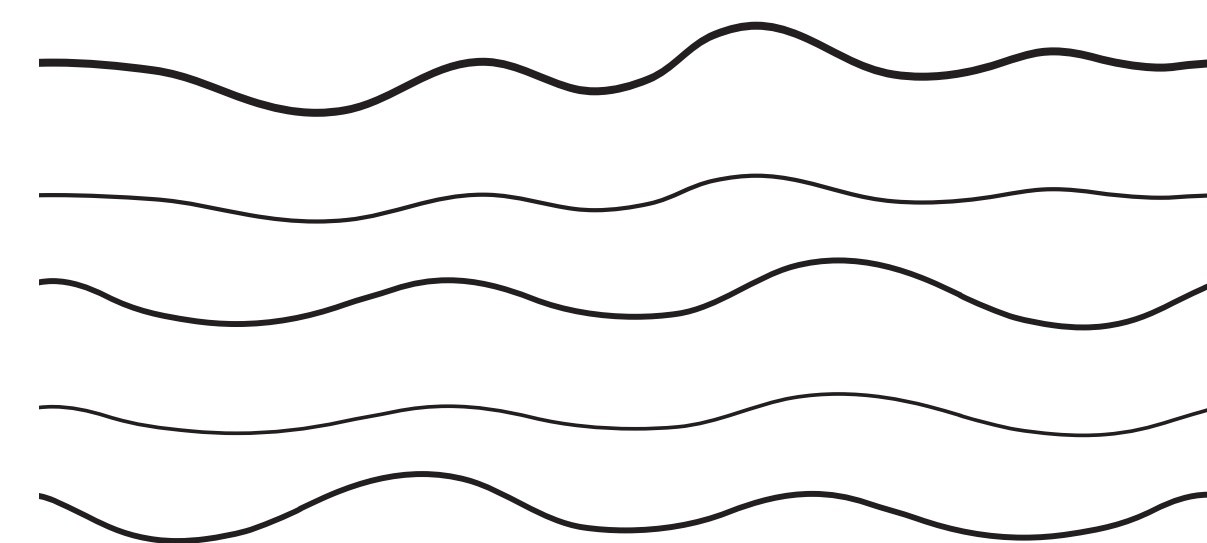

STATES & PRINCIPLES

g

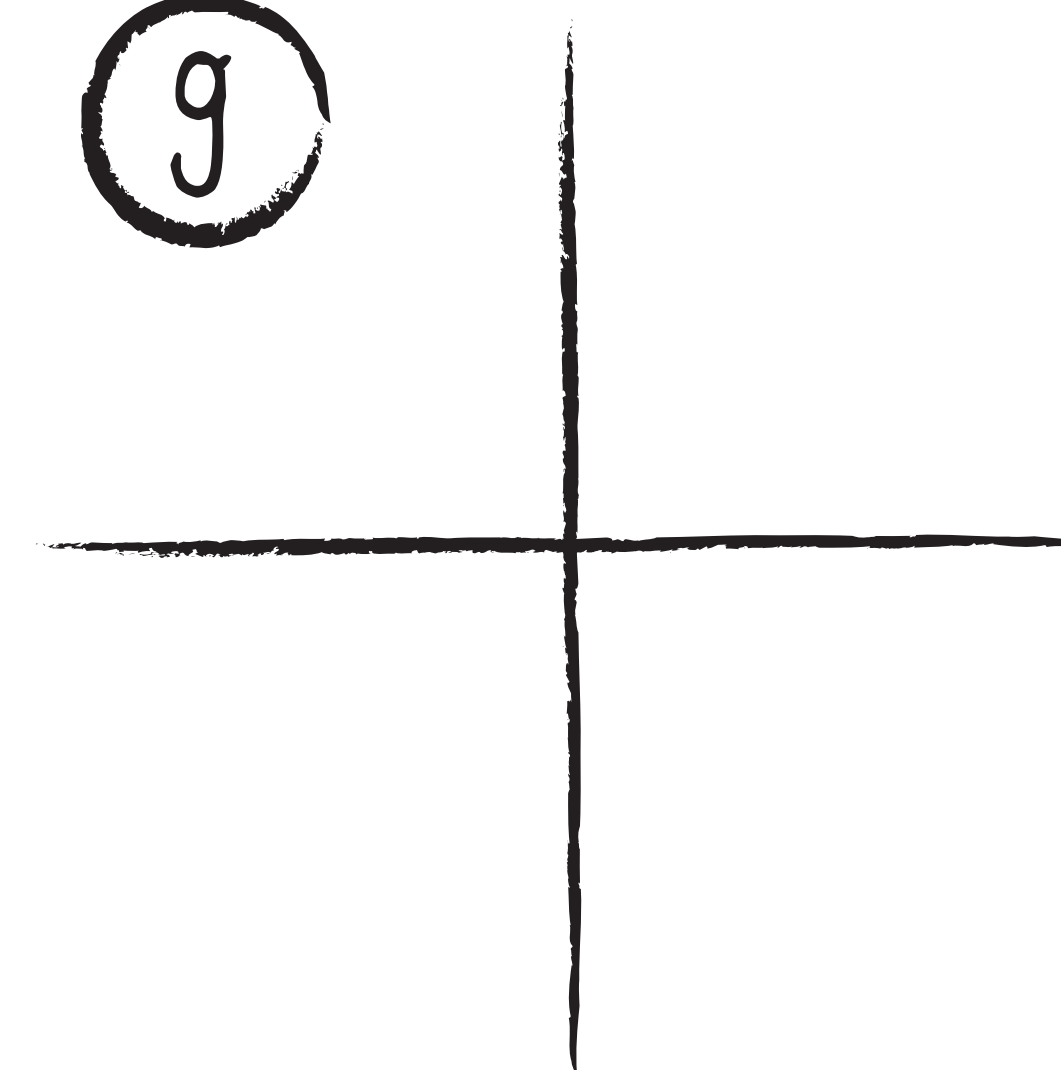

CLUSTERS & CONCERNS

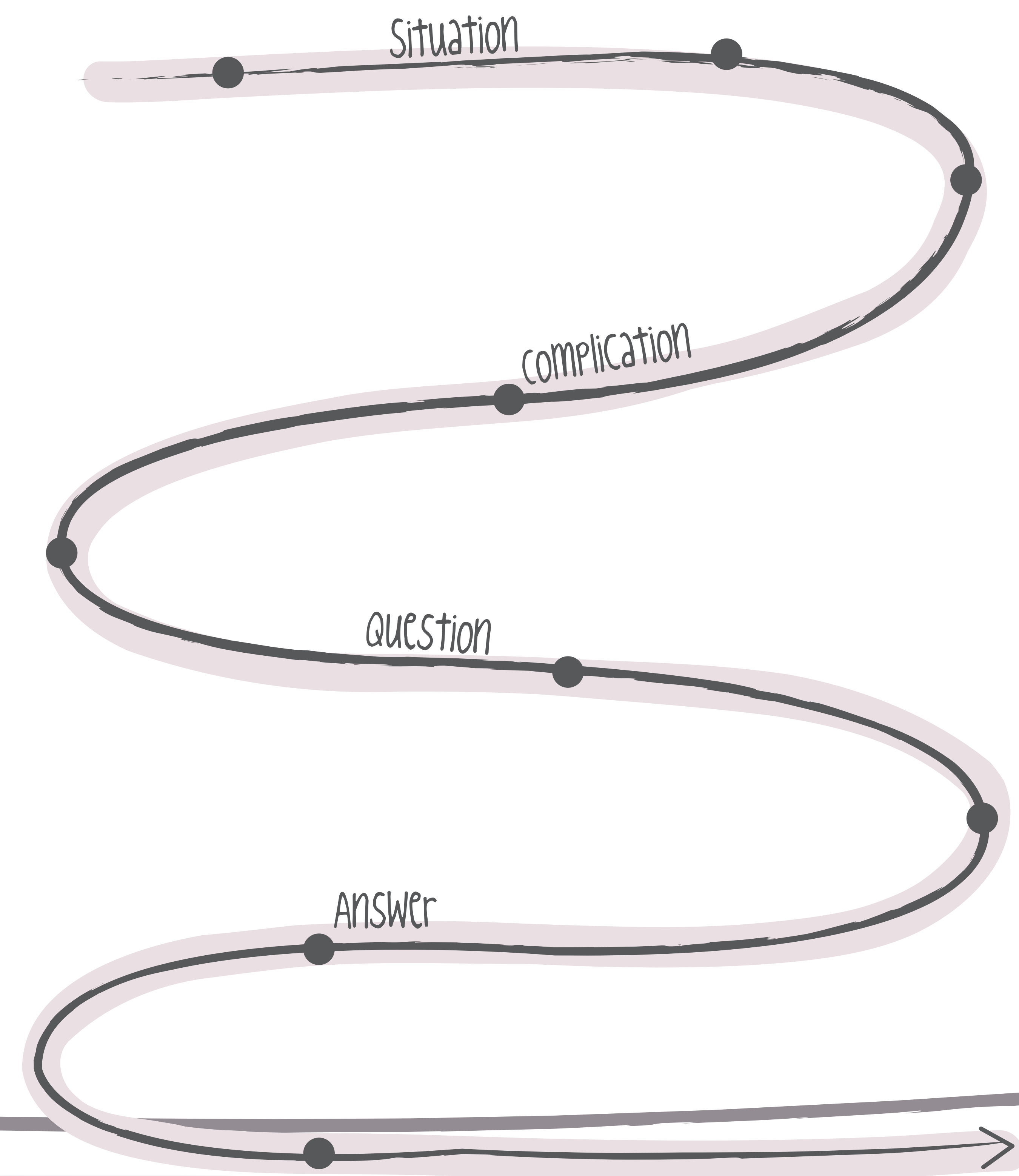
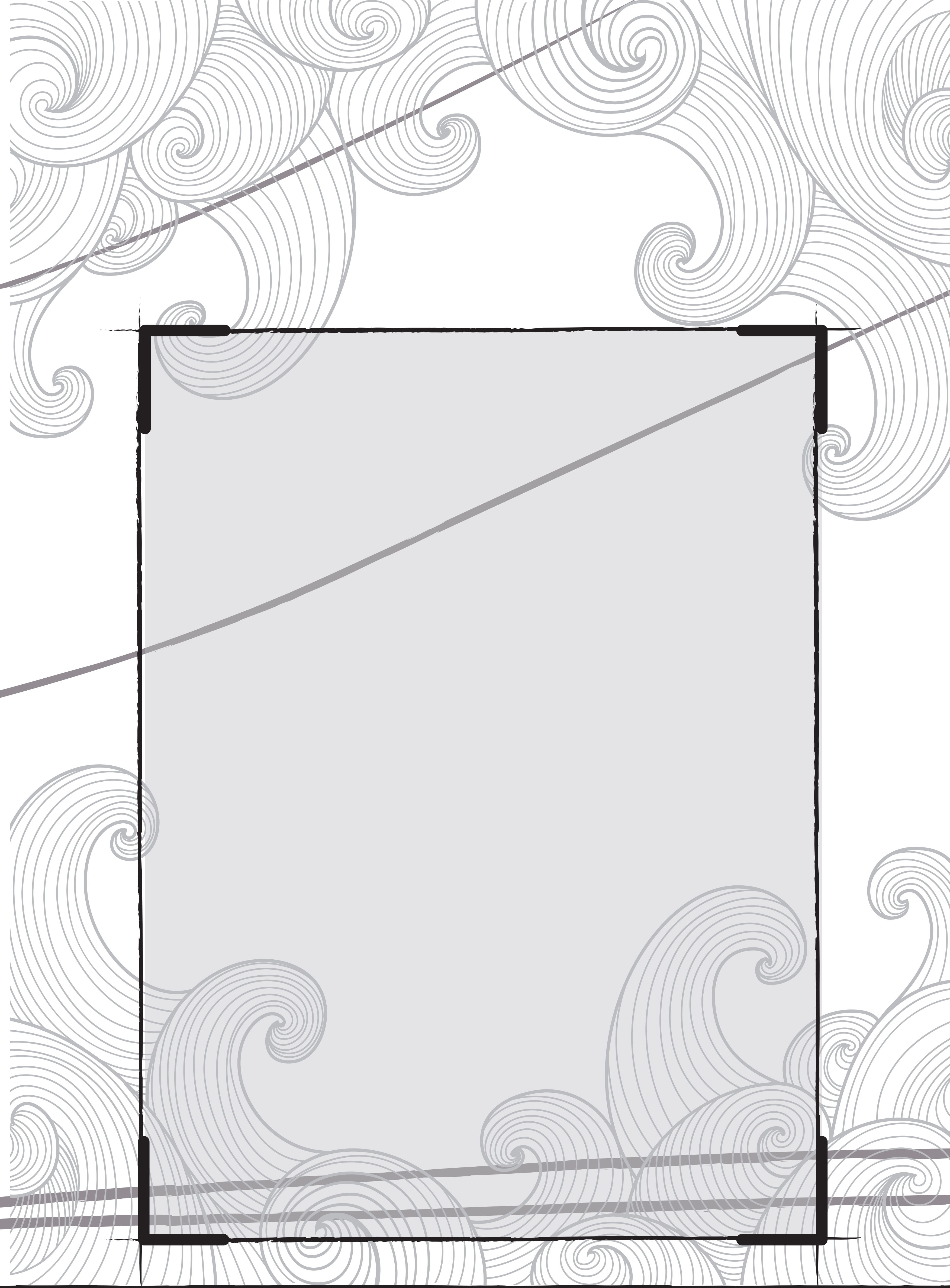

SME: _____
company representatives: _____

DESIGNERS: _____

Vision concept:

Story:

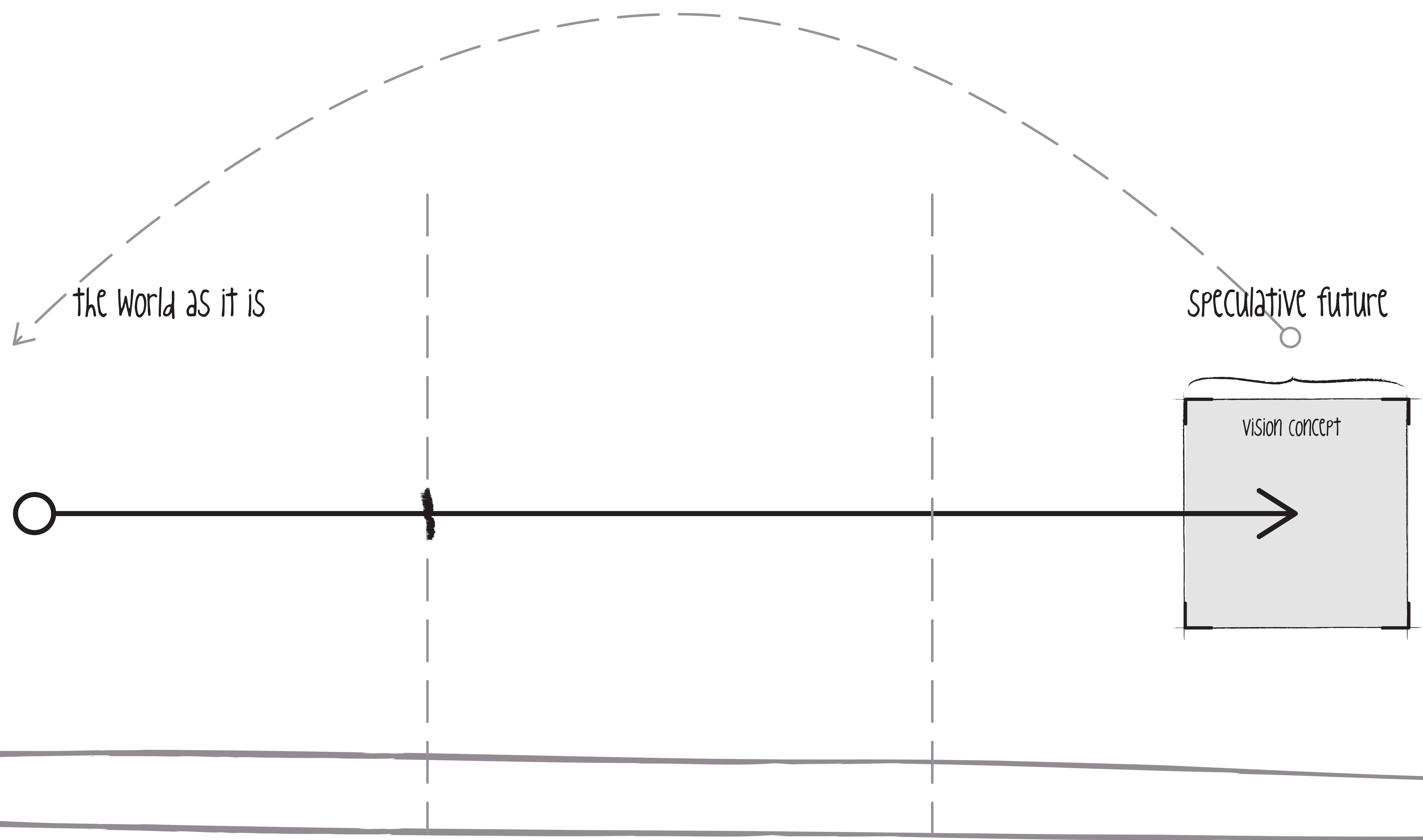

SME: _____
company representatives: _____

DESIGNERS: _____
